

ISOMETRIC

PLAN VIEW

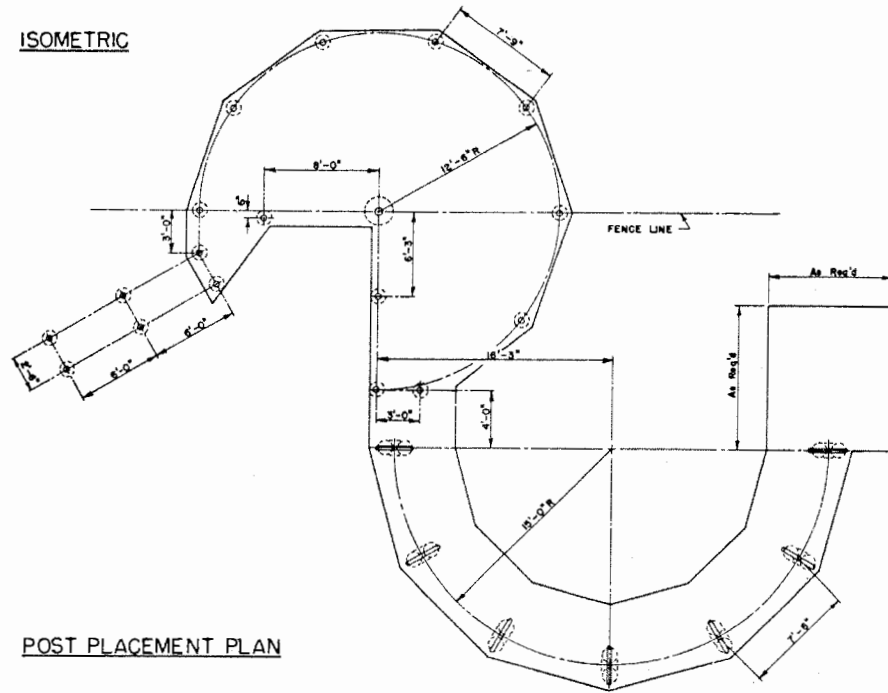

POST PLACEMENT PLAN

THIS PLAN CAN BE DESIGNED TO MATCH HERD SIZES FROM 70 TO MORE THAN 400 HEAD. IT CAN BE BUILT WITH A VARIETY OF PEN SIZES. THE HOLDING PENS NEAR THE SQUEEZE CHUTE PROVIDE AN EXCELLENT LOCATION FOR SICK PENS. PLATFORM SCALES CAN BE LOCATED NEAR THE CROWDING AREA TO WEIGH INCOMING AND OUTGOING CATTLE. FOR SMALL HERDS, THE CORRAL CAN BE BUILT WITH AS FEW AS TWO PIE-SHAPED PENS, THE CROWDING AREA, CURVED WORKING CHUTE, LOADING CHUTE, AND HOLDING PEN SURROUNDING THE WORKING AREA.

THIS CORRAL CAN BE USED AS A HOSPITAL AREA, RECEIVING FACILITY, BACKGROUNDING LOT, OR COMBINATION FOR SMALLER FEEDLOTS AND STOCK OPERATIONS. WORKING AREA CAN BE CONSTRUCTED UNDER A ROOF TO ENSURE ALL-WEATHER USABILITY. THE SMALLER HOLDING PENS CAN BE PLACED IN A BUILDING TO PROVIDE ENVIRONMENTAL PROTECTION FOR SICK ANIMALS. FEEDING BUNKS CAN BE CONSTRUCTED ON THE OUTER FENCE LINES TO ACCOMMODATE DELIVERY FROM MIXER TRUCKS.

THE FIVE PIE-SHAPED PENS AROUND THE PERIMETER OF THE SORTING ALLEY ARE CAPABLE OF HOLDING 150 HEAD OF MATURE CATTLE. ADDING PENS TO THE OUTER PERIMETER OF THE CENTRAL FIVE PENS CAN INCREASE HOLDING CAPACITY TO OVER 400 HEAD. PIE-SHAPED HOLDING PENS MAY BE IDEAL FOR SOME USES, BUT ADDITIONAL FENCING IS REQUIRED COMPARED TO RECTANGULAR PENS OF THE SAME AREA.

NOTES

1. CONSULT LOCAL HEALTH AND BUILDING CODE AUTHORITIES BEFORE STARTING CONSTRUCTION.
2. BEGIN CONSTRUCTION WITH PLACEMENT OF CROWDING GATE POST. THE REMAINDER OF WORKING FACILITY IS LAID OUT FROM THIS POINT.
3. PLACE CONCRETE OVER WELL-DRAINED, UNDISTURBED SOIL, TAMPED SOIL, OR GRAVEL FILL. ALL SURFACE ORGANIC MATTER, MANURE, TRASH, AND SOFT SOIL SHOULD BE REMOVED.
4. USE 6x6, No. 10 WELDED WIRE MESH WITH CONCRETE PLACED OVER SOFT OR SPONGY SOIL.
5. SLOPE CROWDING AREA FLOOR 1/4" PER FOOT TO OUTSIDE FOR DRAINAGE.
6. PROVIDE A ROUGH CONCRETE FINISH TO INSURE STABLE FOOTING FOR ANIMALS.
7. ALL SHEET STEEL MOUNTED INSIDE OF POSTS.

DRAWINGS NOT TO SCALE



EXPANSIBLE CORRALS

OK' 73 6229 SHEET 1 OF 4

REV '86

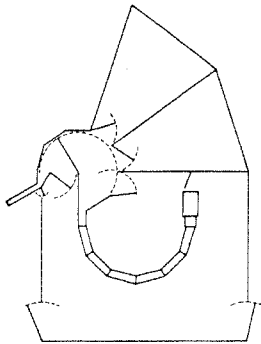

CAPACITY 70 HEAD

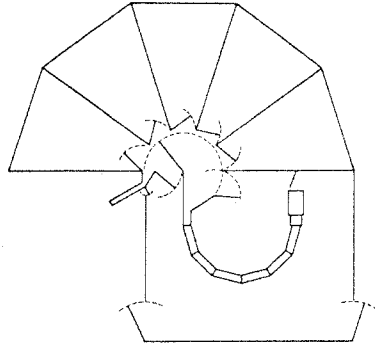

CAPACITY 175 HEAD

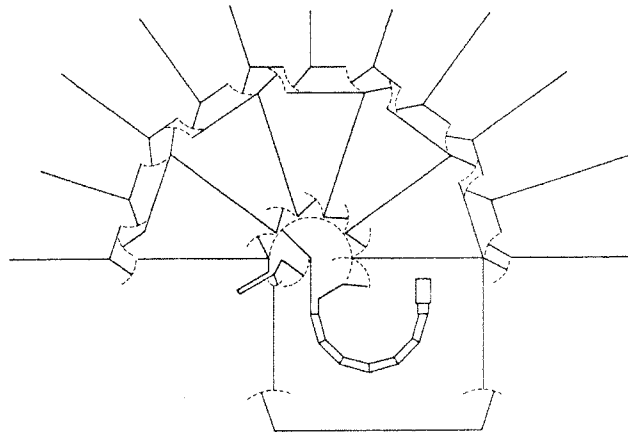

CAPACITY 200 HEAD OR MORE

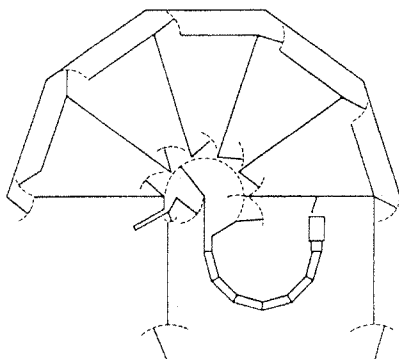

CAPACITY 175 HEAD

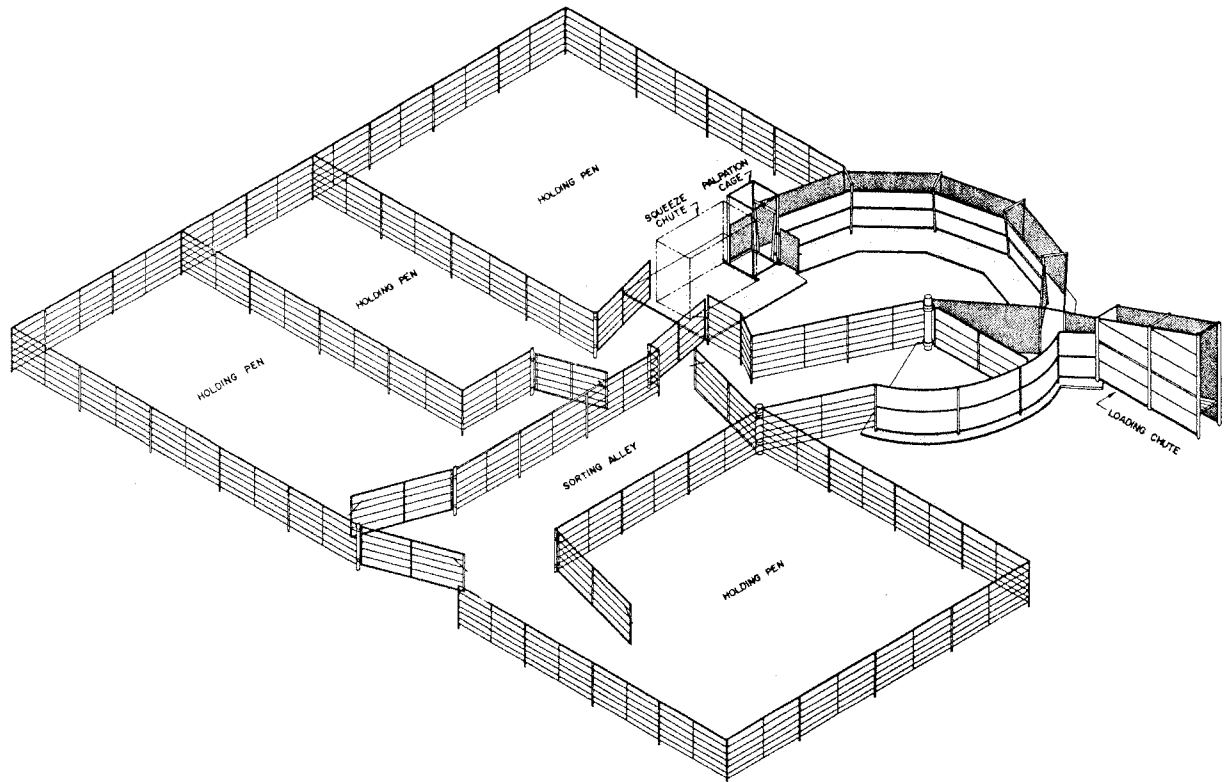

ISOMETRIC

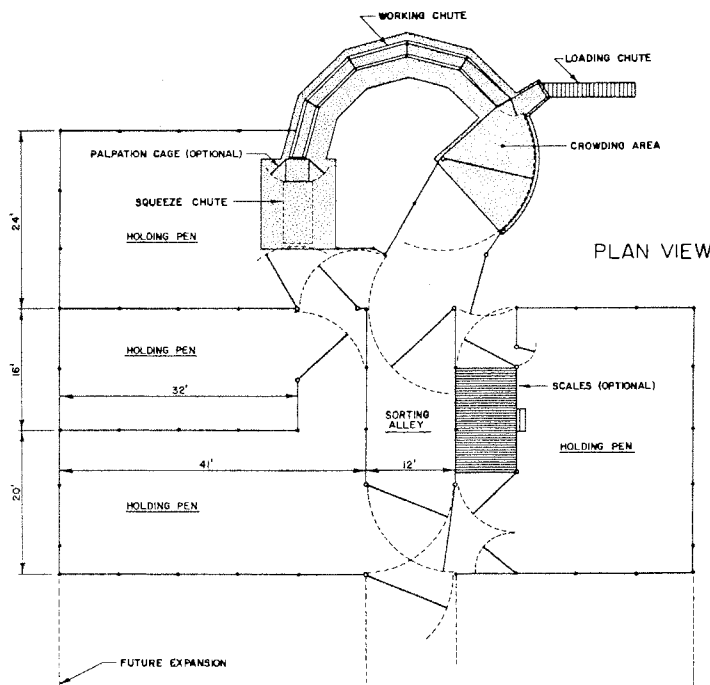

PLAN VIEW

DRAWINGS NOT TO SCALE



EXPANSIBLE CORRALS

OK 73 6229 SHEET 2 OF 4

REV'86

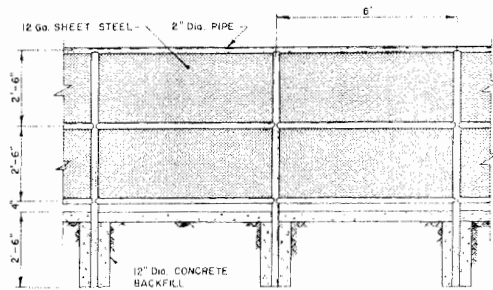

CROWDING AREA FENCE

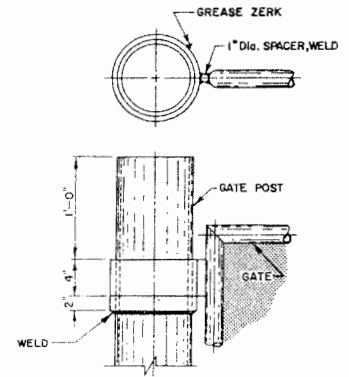
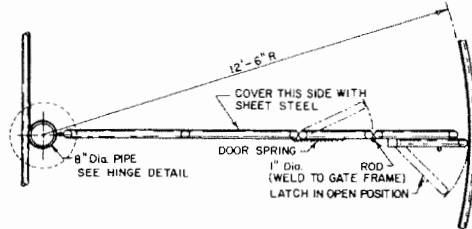

CROWDING GATE HINGE

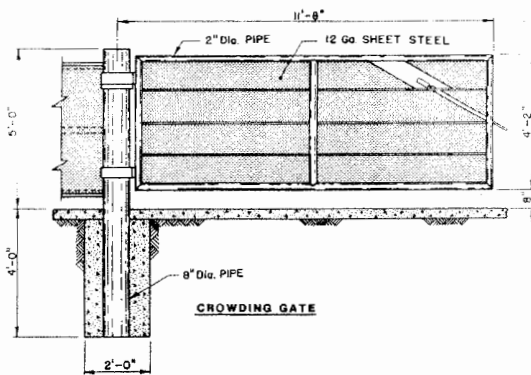

CROWDING GATE

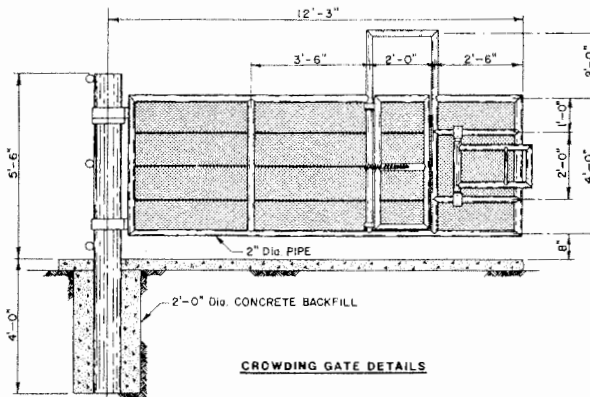

CROWDING GATE DETAILS

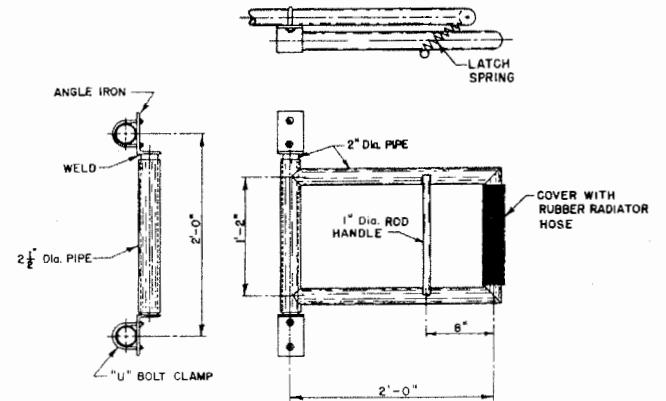

CROWDING GATE LATCH

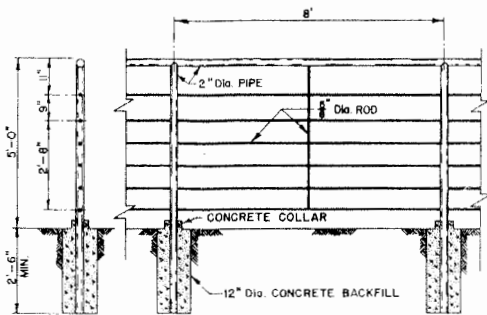

TYPICAL FENCE DETAILS

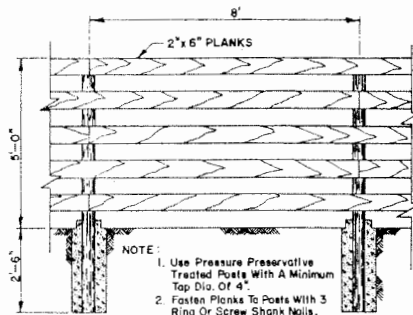

- NOTE:
1. Use Pressure Preservative Treated Posts With A Minimum Top Dia. Of 4".
 2. Fasten Planks To Posts With 3 Ring Or Screw Shank Nails, Staggered To Avoid Splitting The Plank.

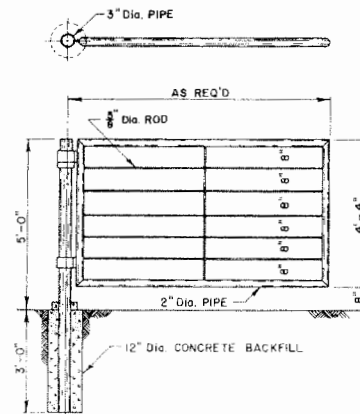

TYPICAL GATE DETAILS

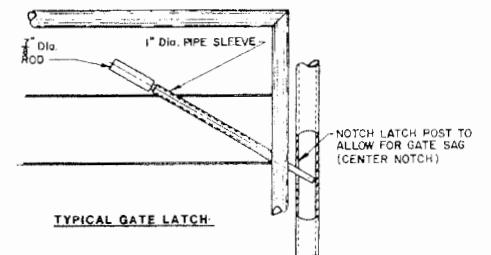

TYPICAL GATE LATCH

DRAWINGS NOT TO SCALE

LSU
AgCenter
Research & Extension

EXPANSIBLE CORRALS

OK' 73 | 6229 | SHEET 3 OF 4

REV 86

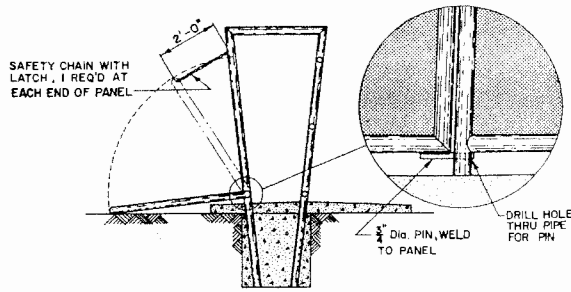

EMERGENCY SIDE EXIT

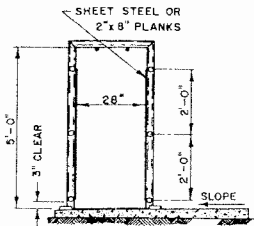

ALTERNATE CONSTRUCTION FOR STATIONARY WORKING CHUTE

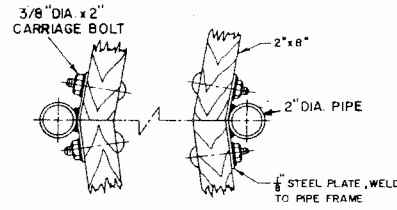

PLANK FASTENING DETAIL

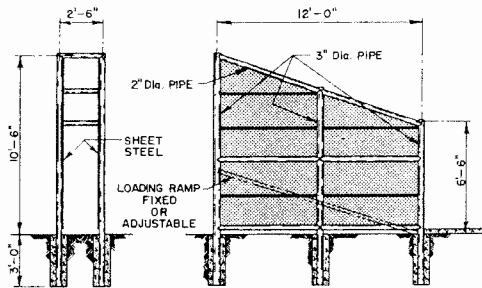
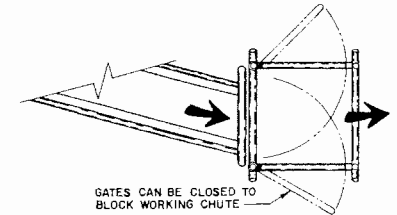

LOADING CHUTE ELEVATIONS

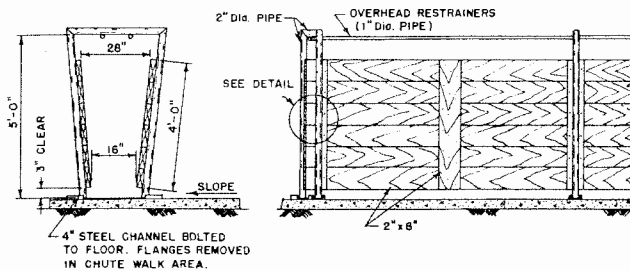

SECTION

ELEVATION

STATIONARY WORKING CHUTE (PIPE AND PLANK)

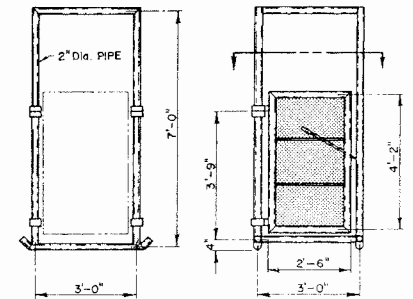

PALPATION CAGE

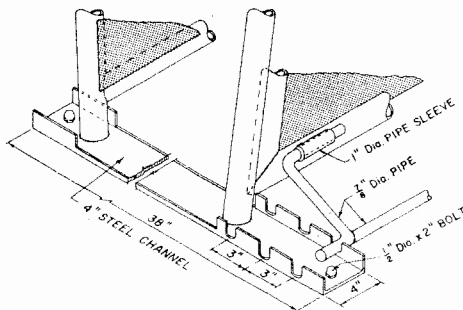

PANEL ADJUSTMENT

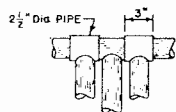

PANEL SUPPORT HINGES

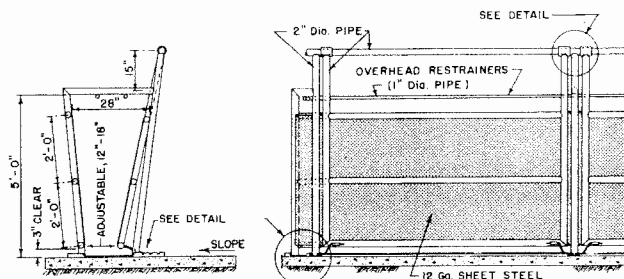

NOTE: AT WIDEST SETTING (18"), ADJUSTABLE PANEL IS FLUSH WITH STATIONARY PIPE SUPPORT.

SECTION

ELEVATION

ADJUSTABLE WORKING CHUTE (PIPE AND SHEET STEEL)

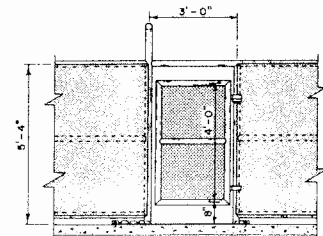

WORKING CHUTE ENTRANCE

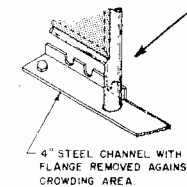

DRAWINGS NOT TO SCALE



EXPANSIBLE CORRALS

OK' 73 6229 SHEET 4 OF 4

REV' 86

Disclaimer

This site makes available conceptual plans that can be helpful in developing building layouts and selecting equipment for various agricultural applications. These plans do not necessarily represent the most current technology or construction codes. They are not construction plans and do not replace the need for competent design assistance in developing safe, legal and well-functioning agricultural building system. The LSU Agriculture Center, the Mid-West Plan Service, the United States Department of Agriculture and none of the cooperating land-grant universities warranty these plans.