

PLAN VIEW OF WORKING CHUTE  
NO SCALE

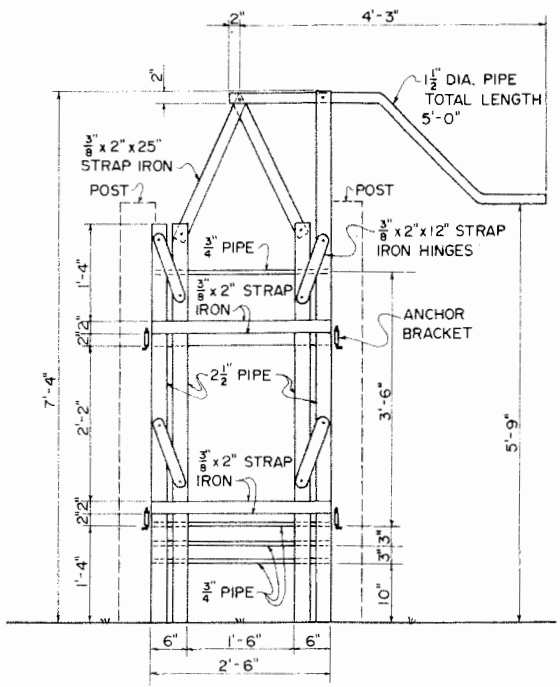

FRONT VIEW OF HEADGATE  
SCALE: 3/4" = 1'-0"

NOTE: CONSTRUCTION MATERIALS ARE PIPE AND STRAP METAL

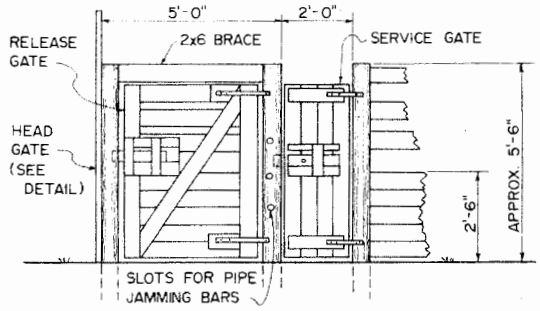

SIDE ELEVATION  
SCALE: 3/8" = 1'-0"

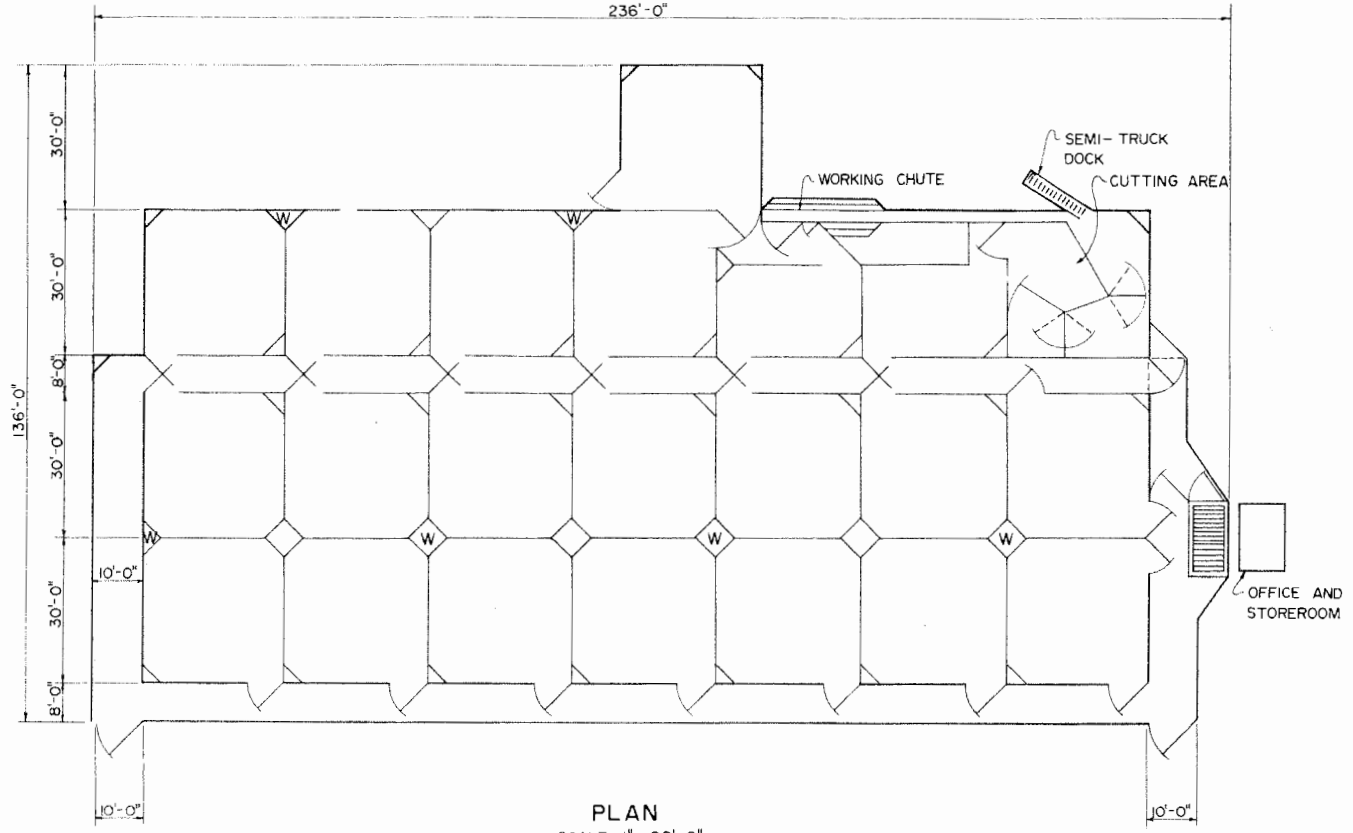

PLAN  
SCALE: 1" = 20'-0"

NOTE: ALL GATES 8'-0" UNLESS OTHERWISE STATED  
ALL HOLDING PENS 30'-0" x 30'-0"

BASED ON NEW MEXICO STATE UNIV. PLAN 842

DESIGNED BY: C. M. HOHN



CORRAL LAYOUT AND EQUIPMENT

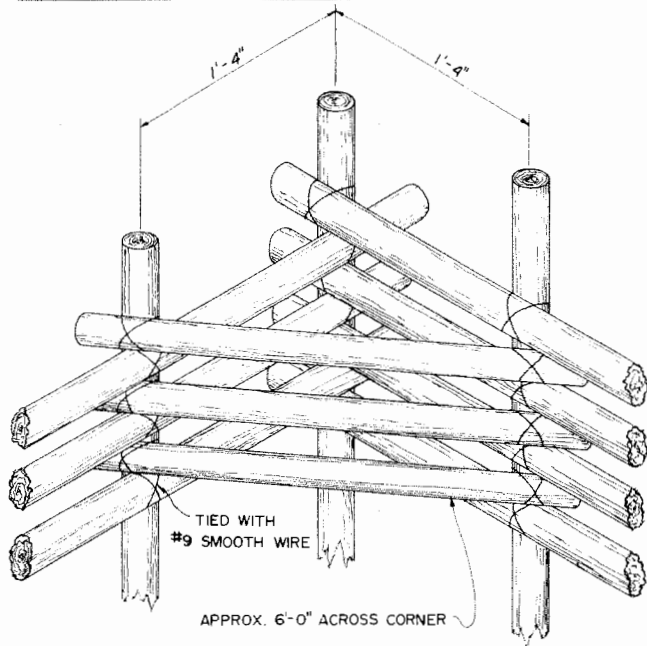

TYPICAL CORNER ARRANGEMENT

NO SCALE

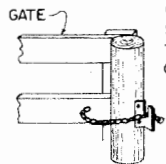

GATE LATCH DETAIL

NO SCALE

GATE POSTS CAN BE SET TO ALLOW GATES TO BUMP OR SWING CLEAR AS DESIRED.

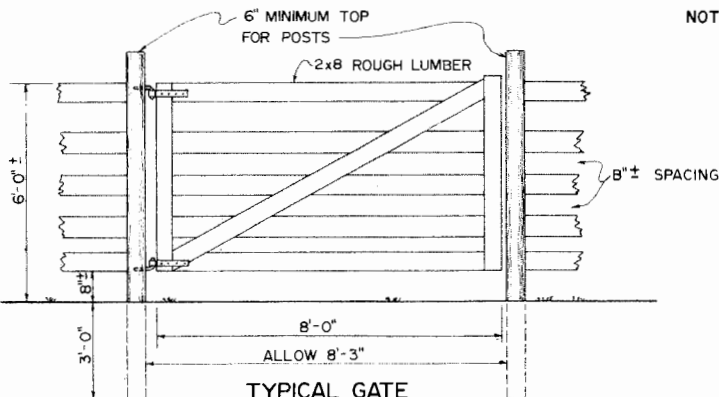

TYPICAL GATE

NO SCALE

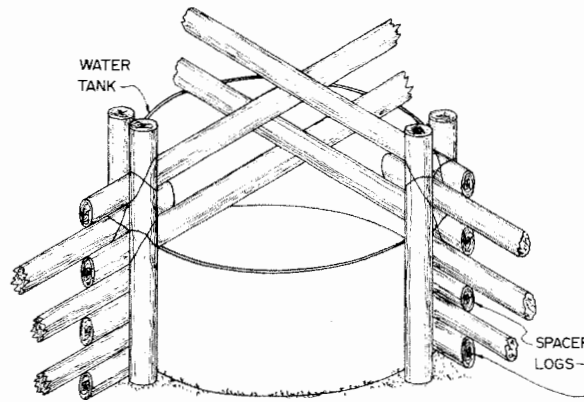

QUARTER VIEW OF FENCE  
DETAIL AT WATER TANK

NO SCALE

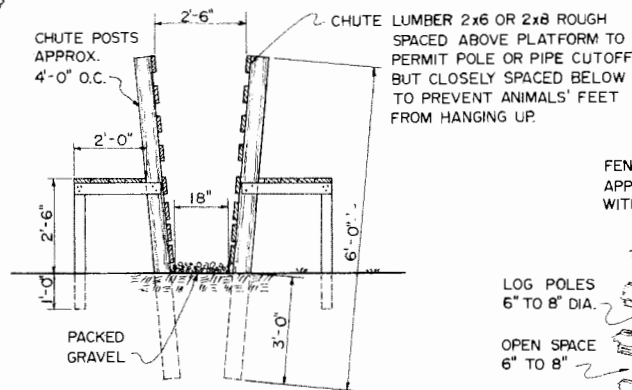

SECTION THROUGH WORKING CHUTE

SCALE:  $\frac{3}{8}$ " = 1'-0"

NOTE: ALL POSTS 6" TO 8" TOP DIAMETER. FOR LONGEST SERVICE ALL WOOD POSTS AND WOOD IN CONTACT WITH GROUND SHOULD BE PRESSURE-TREATED WITH A PRESERVATIVE.

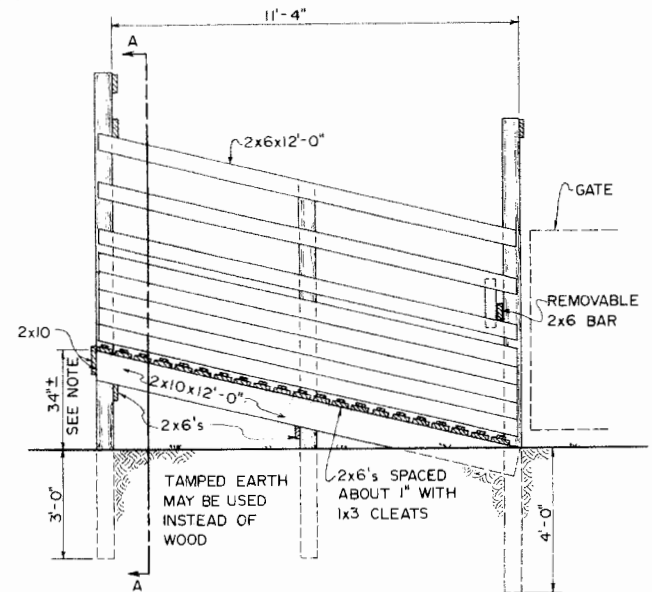

LOADING RAMP  
LONGITUDINAL SECTION

SCALE:  $\frac{3}{8}$ " = 1'-0"

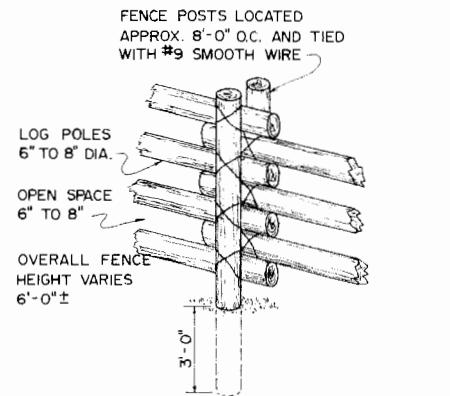

PERSPECTIVE OF TYPICAL FENCE POST

NO SCALE

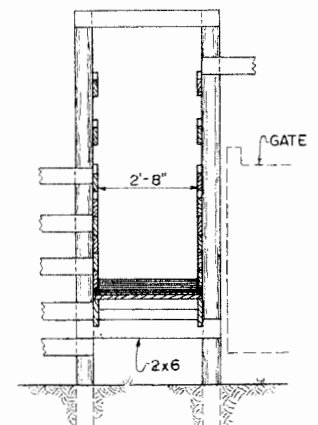

LOADING RAMP  
CROSS SECTION AT A-A

SCALE:  $\frac{3}{8}$ " = 1'-0"

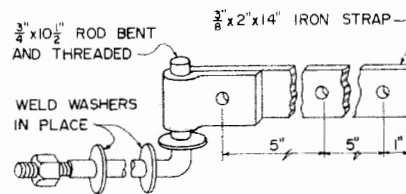

GATE HINGE DETAIL

SCALE: 3" = 1'-0"

**LSU**  
**AgCenter**  
Research & Extension

CORRAL LAYOUT  
AND EQUIPMENT

N. MEX. '70 6106 SHEET 2 OF 3

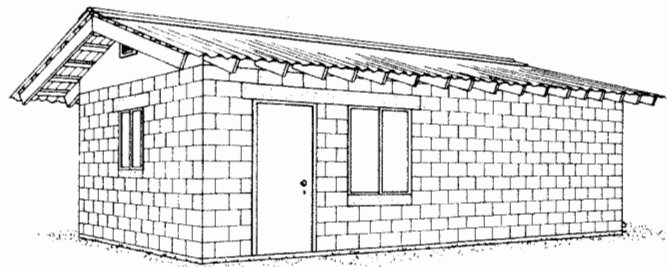

PERSPECTIVE

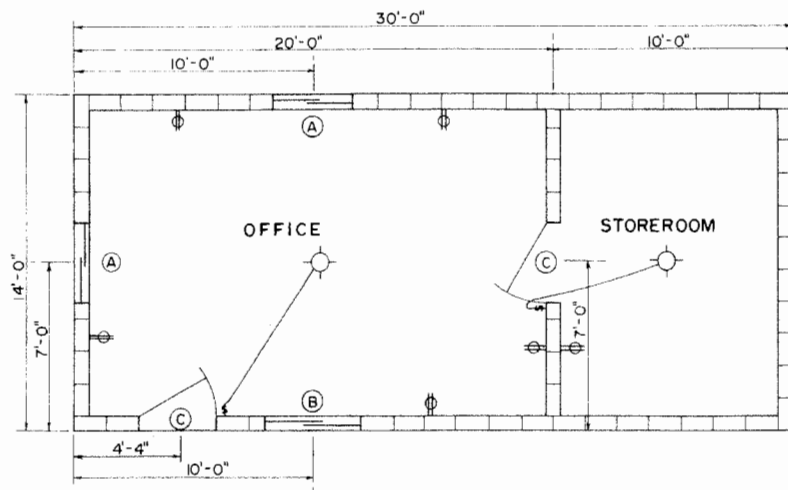
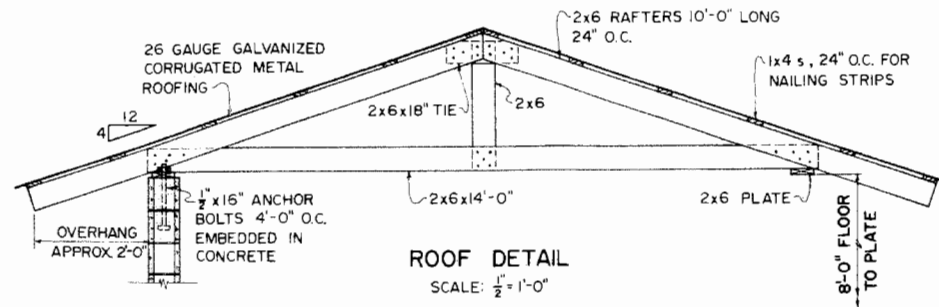

SYMBOLS:

- LIGHT
- ⊕ ELECTRIC OUTLET
- (A) 3'-4" (WIDE) x 3'-0" SLIDING PANEL METAL WINDOW
- (B) 4'-0" (WIDE) x 4'-2" SLIDING PANEL METAL WINDOW
- (C) 3'-0" x 6'-8" WOOD DOOR

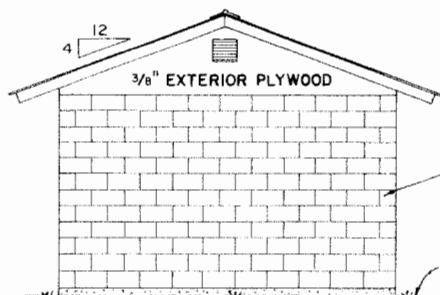
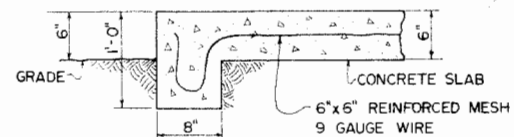

RIGHT ELEVATION  
SCALE:  $\frac{1}{4}'' = 1'-0''$

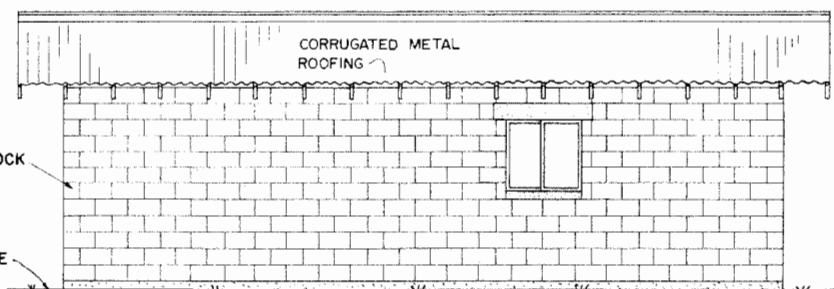

REAR ELEVATION  
SCALE:  $\frac{1}{4}'' = 1'-0''$



CORRAL LAYOUT AND EQUIPMENT

## Disclaimer

This site makes available conceptual plans that can be helpful in developing building layouts and selecting equipment for various agricultural applications. These plans do not necessarily represent the most current technology or construction codes. They are not construction plans and do not replace the need for competent design assistance in developing safe, legal and well-functioning agricultural building system. The LSU Agriculture Center, the Mid-West Plan Service, the United States Department of Agriculture and none of the cooperating land-grant universities warranty these plans.