

**CATTLE DIPPING VAT & INSPECTION FACILITY**

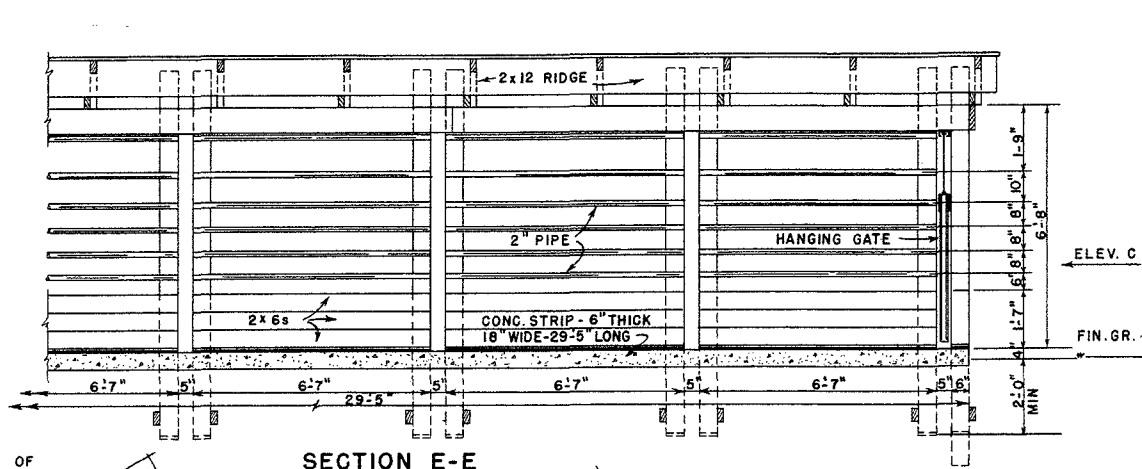

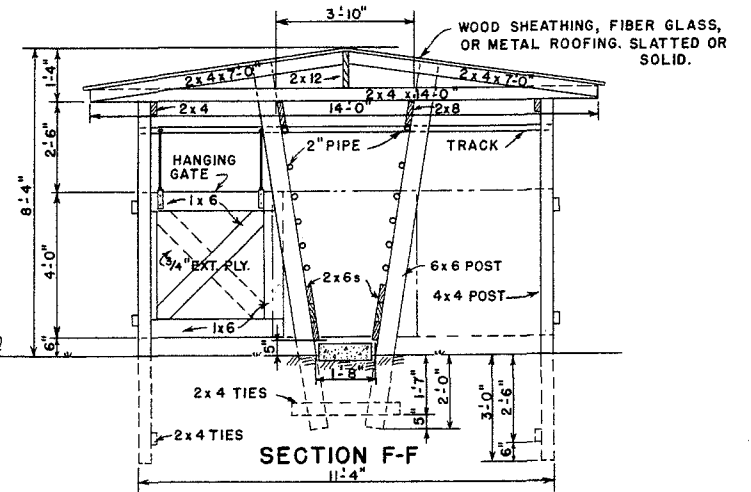

SECTION E-E



SECTION F-F

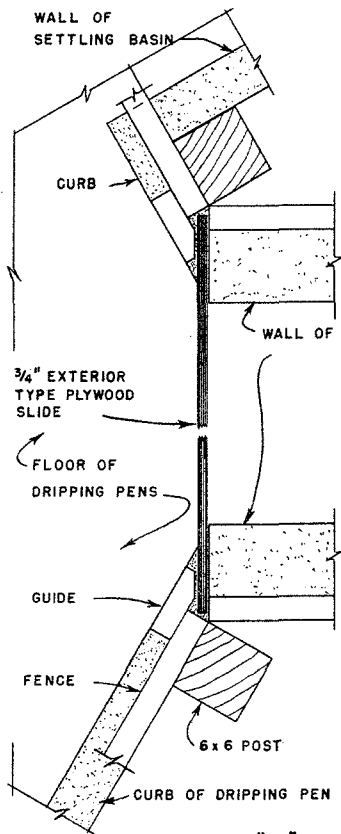

DETAIL "Z"  
SCALE: 1/2" = 1'-0"

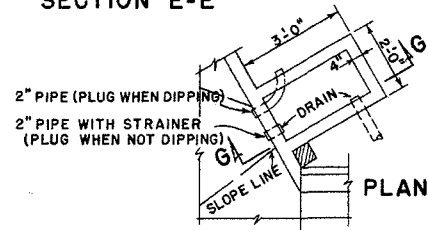

PLAN

DETAIL "Y"

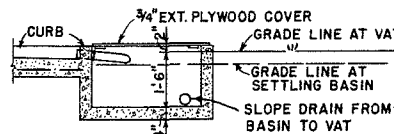

SECTION G-G

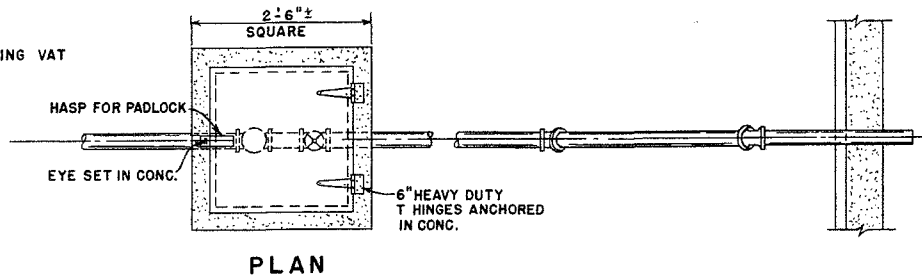

PLAN

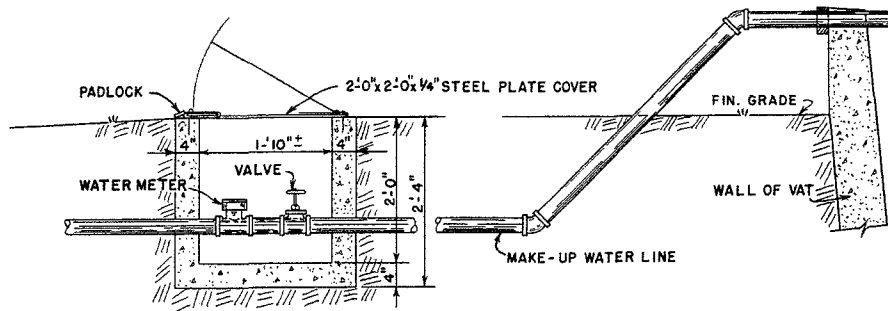

SECTION THRU VALVE BOX  
SCALE: 3/4" = 1'-0"

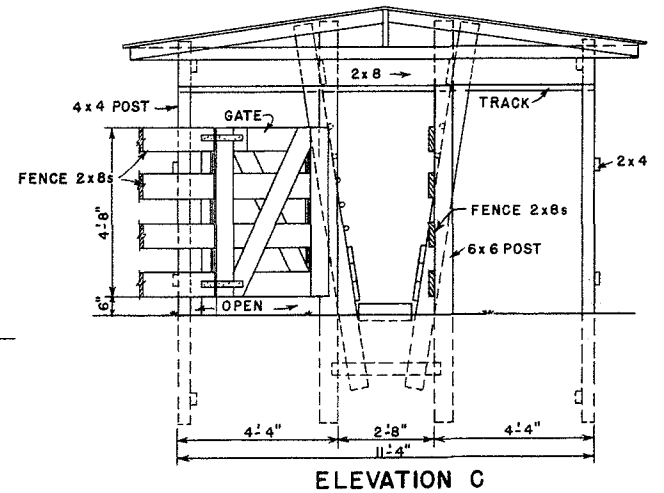

ELEVATION C

SCALE: 3/8" = 1'-0" THROUGH-OUT UNLESS OTHERWISE NOTED.

	
<b>CATTLE DIPPING VAT &amp; INSPECTION FACILITY</b>	
ARS-USDA '62	EX. 5940 SHEET 3 OF 3

## Disclaimer

This site makes available conceptual plans that can be helpful in developing building layouts and selecting equipment for various agricultural applications. These plans do not necessarily represent the most current technology or construction codes. They are not construction plans and do not replace the need for competent design assistance in developing safe, legal and well-functioning agricultural building system. The LSU Agriculture Center, the Mid-West Plan Service, the United States Department of Agriculture and none of the cooperating land-grant universities warranty these plans.